

# 3.0 MPa Maximum Supply Pressure High Pressure Electro-Pneumatic Regulator



Maximum supply pressure **3.0 MPa**

Set pressure range **0.2 to 2.0 MPa**

Stepless control of air pressure up to 2.0 MPa

Stability  **$\pm 1\%$  F.S.\* or less**

\*The value is confined to the static state. Pressure may fluctuate when air is consumed at the output side.

Proof pressure test ((Example) Tank)

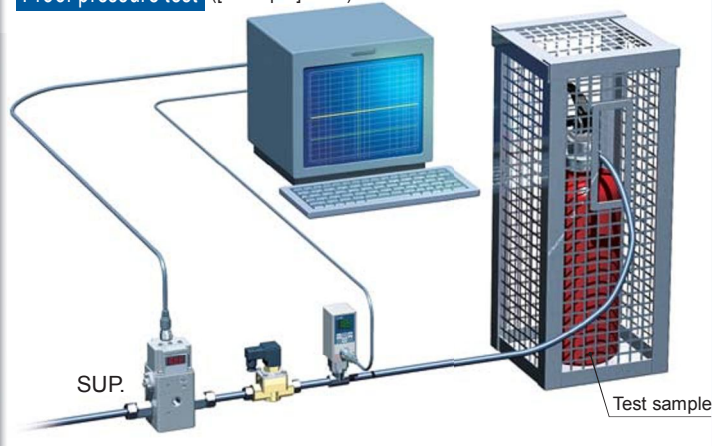

Power consumption **3 W** or less

Maximum flow rate **3000 L/min (ANR)\***

\*Supply pressure: 3.0 MPa, Set pressure: 1.0 MPa

Parts in contact with fluid **Fluorine grease**

Pipe thread type **Rc, NPT, G**

Weight **Approx. 630 g\*** \*Without options

Digital pressure display



## Series ITVH



CAT.EUS60-23A-UK

Linearity

$\pm 1\%$  F.S. or less

Hysteresis

1% F.S. or less

Repeatability

$\pm 1\%$  F.S. or less

### Application Examples

Discharge rate control

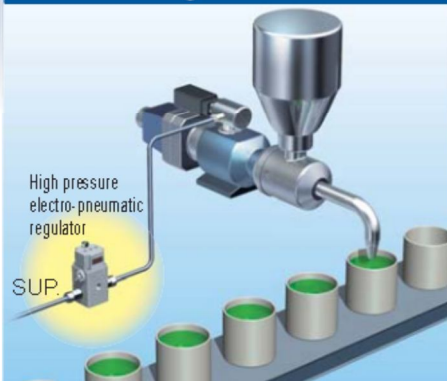

Tension control

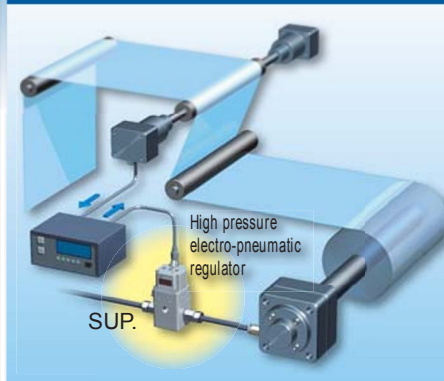

Pressure control for adhesive application

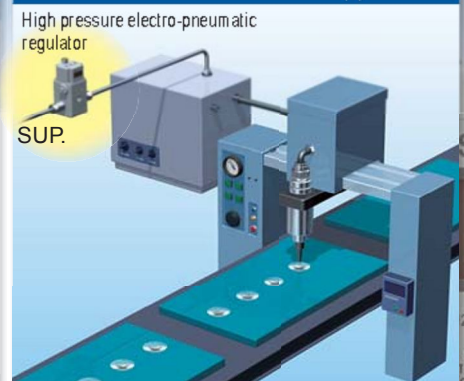

Leak tester

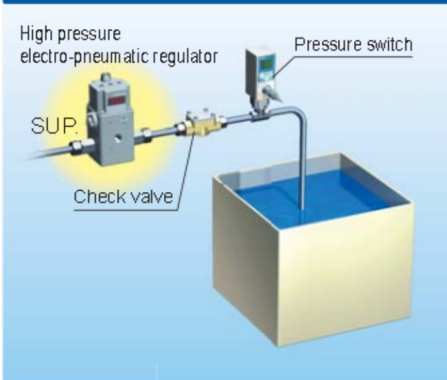

PET bottle molding machine (for remote control of high pressure regulator)

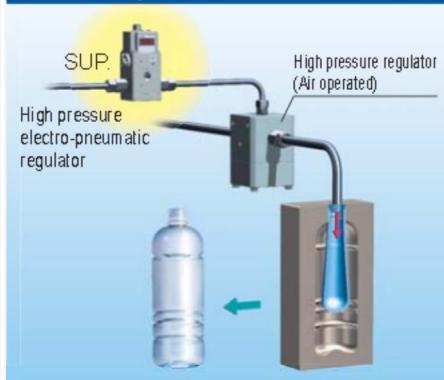

Multi-stage control to analogue control

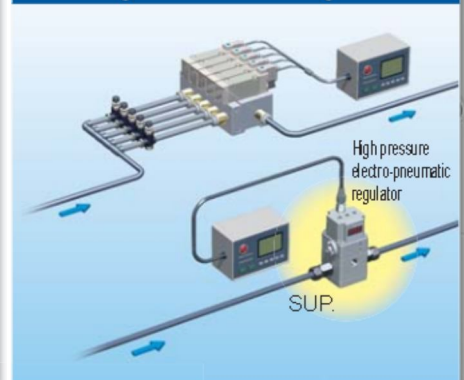



Straight type

Right angle type



Variation Map

Series	Model	Maximum supply pressure [MPa]				Set pressure range [MPa]				Port size	Maximum flow rate
		0.2	1.0	3.0	5.0	0.005	0.01	0.1	0.5		
3.0 MPa Maximum Supply Pressure High Pressure Electro-Pneumatic Regulator <b>New Series ITVH</b> 	ITVH2020	3.0				0.2 2.0				1/4 3/8	3000 L/min (ANR)  (Supply pressure: 3.0 MPa) (Set pressure: 1.0 MPa)
Compact Electro-Pneumatic Regulator Series ITV0000 	ITV001□	0.2				0.001 0.1				Built-in One-touch fittings ø4 ø5/32	6 L/min (ANR)  (Supply pressure: 1.0 MPa) (Set pressure: 0.6 MPa)
	ITV003□	1.0				0.001 0.5					
	ITV005□	1.0				0.001 0.9					
Electro-Pneumatic Regulator Series ITV1000 	ITV101□	0.2				0.005 0.1				1/8 1/4	200 L/min (ANR)  (Supply pressure: 1.0 MPa) (Set pressure: 0.6 MPa)
	ITV103□	1.0				0.005 0.5					
	ITV105□	1.0				0.005 0.9					
Electro-Pneumatic Regulator Series ITV2000 	ITV201□	0.2				0.005 0.1				1/4 3/8	1500 L/min (ANR)  (Supply pressure: 1.0 MPa) (Set pressure: 0.6 MPa)
	ITV203□	1.0				0.005 0.5					
	ITV205□	1.0				0.005 0.9					
Electro-Pneumatic Regulator Series ITV3000 	ITV301□	0.2				0.005 0.1				1/4 3/8 1/2	4000 L/min (ANR)  (Supply pressure: 1.0 MPa) (Set pressure: 0.6 MPa)
	ITV303□	1.0				0.005 0.5					
	ITV305□	1.0				0.005 0.9					
5.0 MPa Maximum Supply Pressure High Pressure Electro-Pneumatic Regulator Series ITVX 	ITVX2030	5.0				0.01 3.0				3/8	3000 L/min (ANR)  (Supply pressure: 5.0 MPa) (Set pressure: 3.0 MPa)

 Digital Catalogue  
Visit [www.smc.eu](http://www.smc.eu)

\* The outlet of the ITVX series is released to the atmosphere for blowing

3.0 MPa Maximum Supply Pressure



High Pressure Electro-Pneumatic Regulator



# Series ITVH2000

## How to Order

ITVH2020-01□2□S□

Set pressure range

2	0.2 to 2.0 MPa
---	----------------

Power supply voltage

0	24 VDC
---	--------

Input signal

0	Current type 4 to 20 mA DC
1	Current type 0 to 20 mA DC
2	Voltage type 0 to 5 VDC
3	Voltage type 0 to 10 VDC
40	4 points preset input type

Monitor output

—	None (Preset input only)
1	Analogue output 1 to 5 VDC
2	Switch output/NPN output
3	Switch output/PNP output
4	Analogue output 4 to 20 mA DC (Sink type/+ COM type)

Pipe thread type

—	Rc
N	NPT
F	G (Note)

Note) Complies with ISO1179-1 (2007).

Port size

2	1/4
3	3/8

Note) EXH port: 1/4  
Built-in regulator EXH port: M5  
Solenoid valve EXH port: M5

Pressure display unit

—	MPa
2	kgf/cm <sup>2</sup>
3	bar
4	psi

Cable connector type

—	Straight type 3 m	
S		
—	Right angle type 3 m	
L		
N	Without cable connector	

Bracket\*

—	Without bracket	
—	Flat bracket	
B		
—	L-bracket	
C		

\*Bracket is included.

## Standard Specifications



Symbol

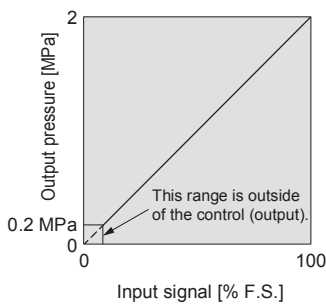
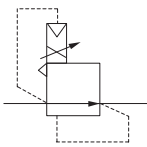

Fig. 1. Input/output characteristics chart

Model		ITVH2000
Minimum supply pressure		Whichever is higher: 0.5 MPa or the set pressure + 0.2 MPa
Maximum supply pressure		3.0 MPa
Set pressure range <sup>Note 1)</sup>		0.2 to 2.0 MPa
Power supply	Voltage	24 VDC $\pm 10\%$
	Current consumption	0.12 A or less
Input signal	Current type <sup>Note 2)</sup>	4 to 20 mA DC, 0 to 20 mA DC (Sink type/+ COM type)
	Voltage type	0 to 5 VDC, 0 to 10 VDC
	Preset input type	4 points (Negative common)
Input impedance	Current type	500 $\Omega$ or less
	Voltage type	6.0 to 6.5 k $\Omega$ (at 25°C)
	Preset input type	Approx. 4.7 k $\Omega$
Output signal <sup>Note 3)</sup> (Monitor output)	Analogue output	1 to 5 VDC Output impedance: 1 k $\Omega$ or more Output accuracy: $\pm 6\%$ F.S. or less
		4 to 20 mA (Sink type/+ COM type) Output impedance: 250 $\Omega$ or less Output accuracy: $\pm 6\%$ F.S. or less
	Switch output	NPN open collector output: Max. 30 V, 80 mA Hysteresis: $\pm 3\%$ F.S. Self-diagnosis: $\pm 5\%$ F.S. or less
		PNP open collector output: Max. 80 mA Hysteresis: $\pm 3\%$ F.S. Self-diagnosis: $\pm 5\%$ F.S. or less
Linearity		$\pm 1\%$ F.S. or less
Hysteresis		1% F.S. or less
Repeatability		$\pm 1\%$ F.S. or less
Sensitivity		$\pm 1\%$ F.S. or less
Temperature characteristics		$\pm 0.12\%$ F.S. or less/ $^{\circ}\text{C}$
Output pressure display	Accuracy	$\pm 2\%$ F.S. or less $\pm 1$ digit
	Minimum unit <sup>Note 4)</sup>	MPa: 0.01, kgf/cm <sup>2</sup> : 0.1, bar: 0.1, psi: 1
Ambient and fluid temperature		0 to 50°C (No condensation)
Weight		Approx. 630 g (without options)

Note 1) Refer to Figure 1 for the relationship between set pressure and input signal.

Note 2) 2-wire type 4 to 20 mA is not available. Power supply voltage 24 VDC is required.

Note 3) Select either analogue output or switch output. Further, when switch output is selected, select either NPN output or PNP output. When measuring analogue output of 1 to 5 VDC with a load impedance less than 100 k $\Omega$ , the analogue output may not obtain the output accuracy of  $\pm 6\%$  F.S. or less.

Note 4) Adjustment of numerical values such as the zero/span adjustment is set based on the minimum units for output pressure display. Note that the unit cannot be changed.

Note 5) The above characteristics are confined to the static state. When air is consumed on the output side, the pressure may fluctuate.

# Series ITVH2000

## Accessories (Option)/Part No.

Description	Part no.
Flat bracket assembly (including mounting screws)	P398020-600
L-bracket assembly (including mounting screws)	P398020-601
Power cable connector	Straight type 3 m
	Right angle type 3 m

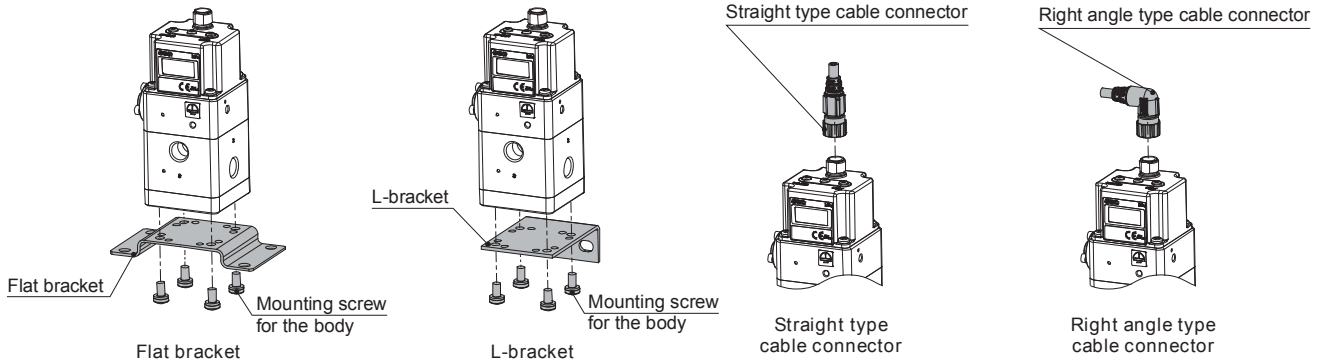

## Dimensions

Flat bracket

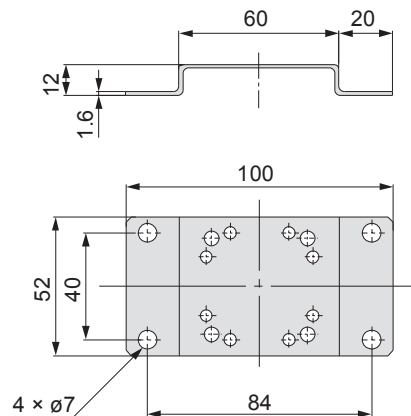

L-bracket

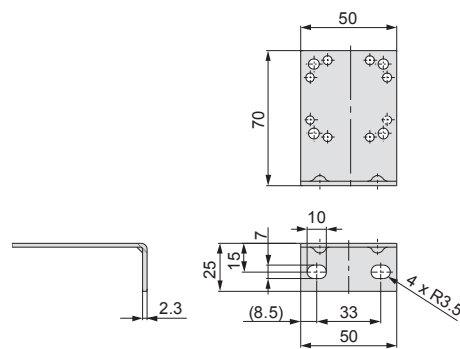

## Working Principle

When the input signal rises, the air supply solenoid valve  $q$  turns ON, and the exhaust solenoid valve  $w$  turns OFF. Therefore, supply pressure regulated by a built-in regulator  $e$  passes through the air supply solenoid valve  $q$  and is applied to the pilot chamber  $r$ . The pressure in the pilot chamber  $r$  increases and operates on the upper surface of the diaphragm  $t$ .

As a result, the air supply valve  $y$  linked to the diaphragm  $t$  opens, and a portion of the supply pressure becomes output pressure.

This output pressure feeds back to the control circuit  $i$  via the pressure sensor  $u$ . Here, a correct operation functions until the output pressure is proportional to the input signal, making it possible to always obtain output pressure proportional to the input signal.

Working Principle Diagram

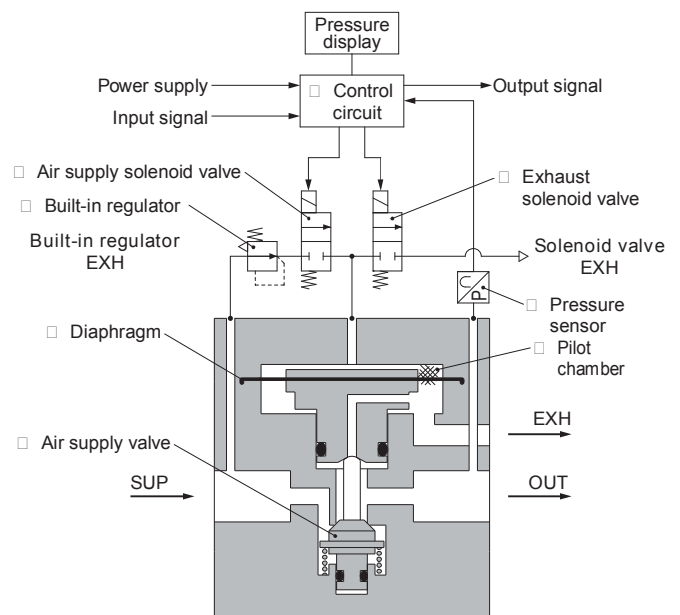

Series ITVH2000

Linearity

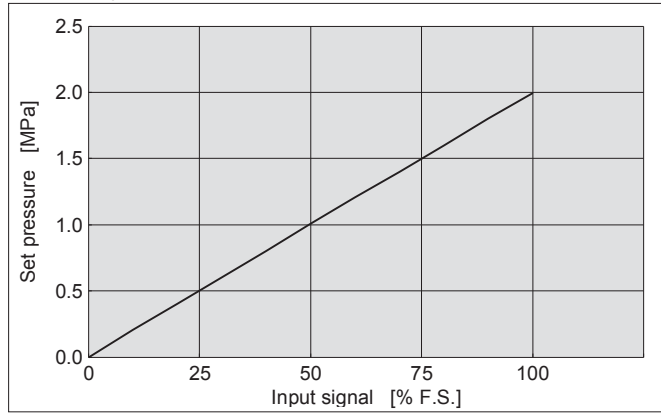

Hysteresis

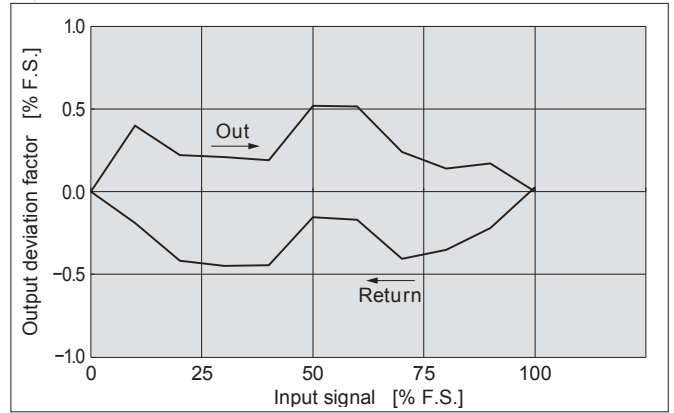

Repeatability

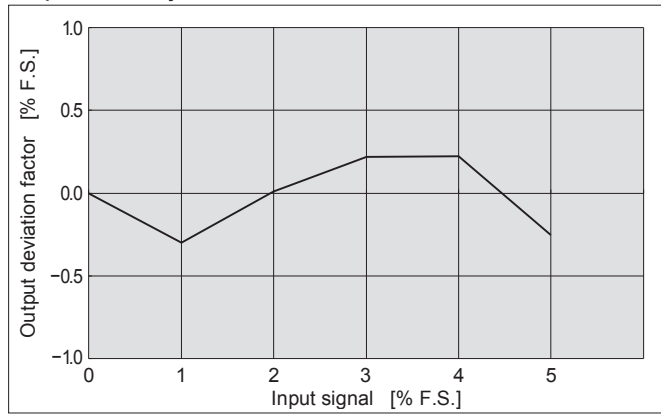

Pressure Characteristics

Set pressure: 1.0 MPa

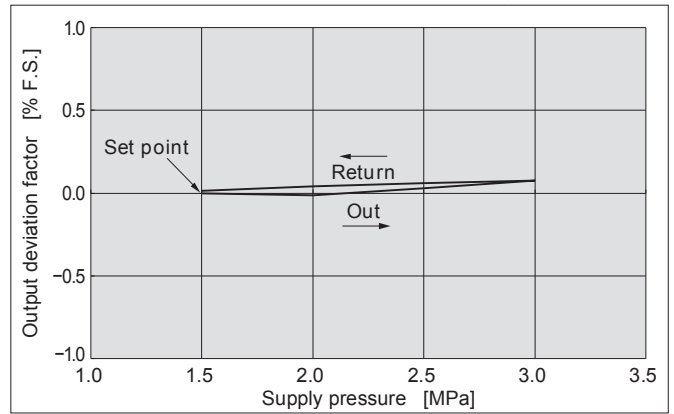

Flow-rate Characteristics

Supply pressure: 1.0 MPa

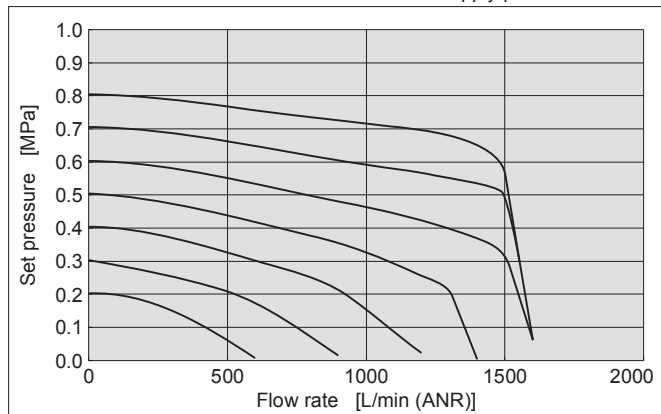

Relief Characteristics

Supply pressure: 1.0 MPa

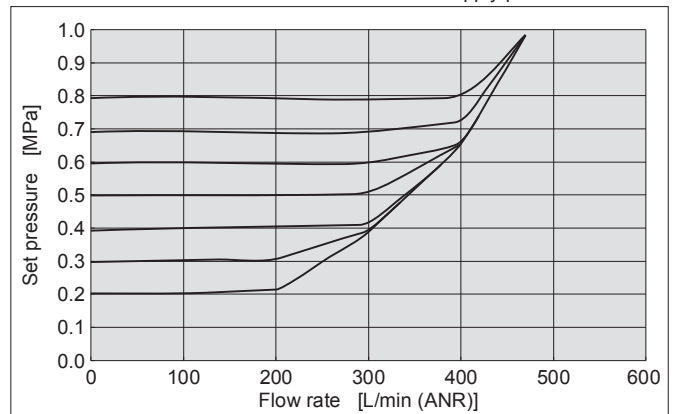

# Series ITVH2000

## Dimensions

Do not turn the right angle type cable connector. It does not rotate and is limited to only one entry direction.

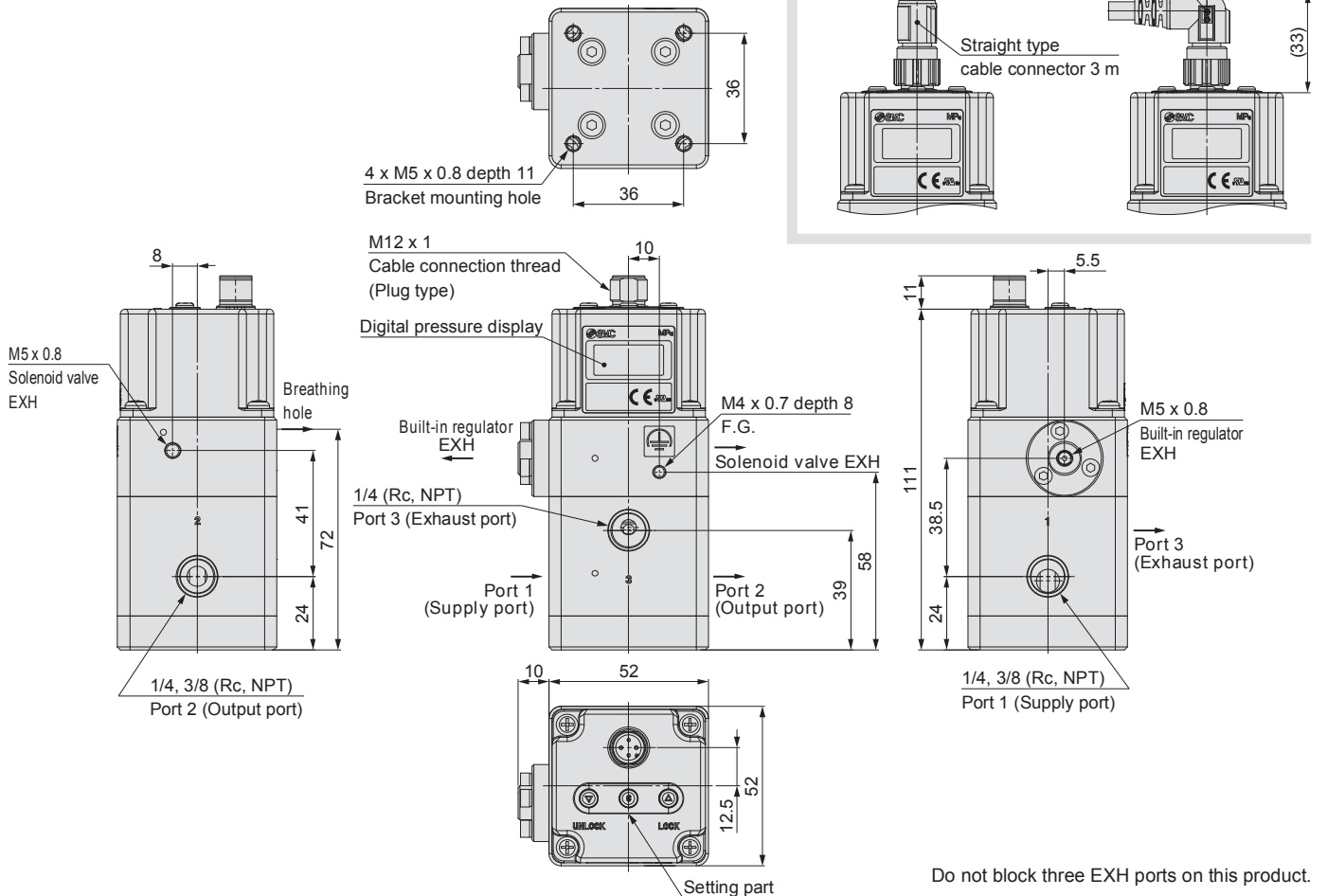
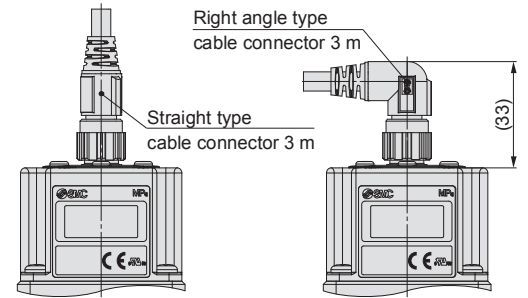

Do not block three EXH ports on this product.

### With L-bracket

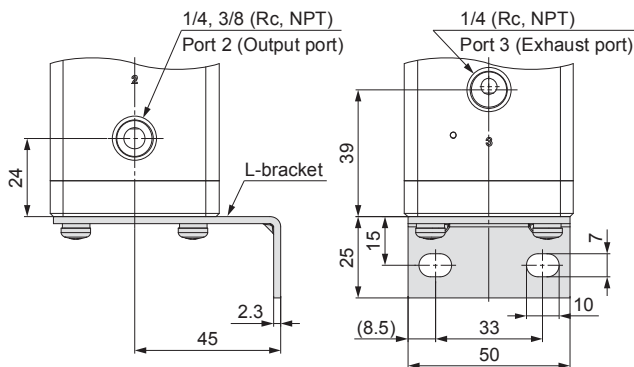

### With flat bracket

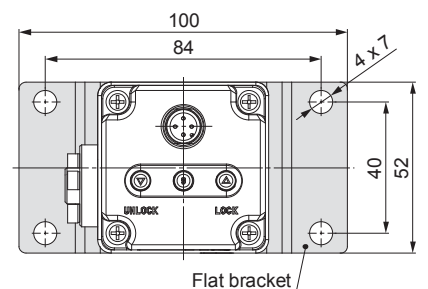
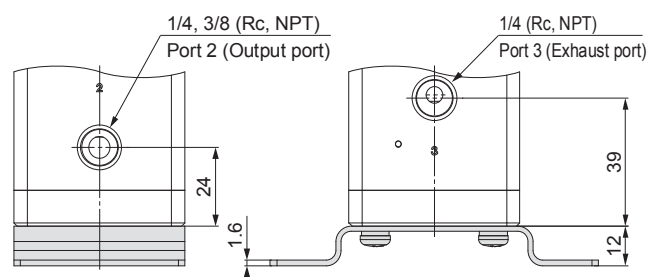

### G thread

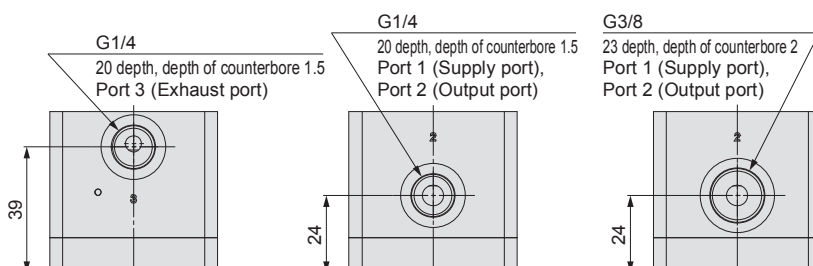





# Series ITVH2000

## Specific Product Precautions 1

Be sure to read this before handling. Refer to the back cover for Safety Instructions. For F.R.L. Precautions, refer to "Handling Precautions for SMC Products" and the Operation Manual on SMC website, <http://www.smc.eu>

### Piping

#### Warning

1. Screw piping together with the recommended proper torque while holding the side with the female threads. Looseness or faulty sealing will occur if tightening torque is insufficient, while thread damage will result if the torque is excessive. Furthermore, if the side with the female threads is not held while tightening, excessive force will be applied directly to piping brackets etc., causing damage or other problems.

Connection thread	Recommended proper torque [N·m]
M5	1.5 to 2
1/4	8 to 12
3/8	15 to 20

2. Do not allow twisting or bending moment to be applied other than the weight of the equipment. Provide separate support for external piping, as damage may otherwise occur.
3. Since excessive moment loads and the propagation of vibrations, etc. can easily result from inflexible piping made of materials such as steel, avoid these problems by using flexible tubing for intermediate connections.
4. Piping port indication  
When connecting piping to a product, refer to the Operation Manual to avoid mistakes regarding the port.  
Port 1: Supply port  
Port 2: Output port  
Port 3: Exhaust port
5. Exhaust port  
Do not reduce the diameter of port 3 (the exhaust port), EXH port of solenoid valve, or EXH port of built-in regulator too much or block it. It will lead to an operation failure.

#### Caution

1. Preparation before piping  
Before piping is connected, it should be thoroughly blown out with air (flushing) or washed to remove chips, cutting oil and other debris from inside the pipe.
2. Wrapping of sealant tape  
When screwing together pipes and fittings, etc., be certain that chips from the pipe threads and sealing material do not get inside the piping.  
Also, when sealant tape is used, leave 1.5 to 2 thread ridges exposed at the end of the threads.

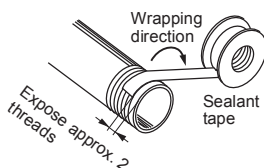

### Operating Environment

#### Warning

1. Do not operate in locations having an atmosphere of corrosive gases, chemicals, sea water, or where there will be contact with the same.

#### Caution

1. In locations where the body is exposed to water, steam, dust, etc., there is a possibility that moisture or dust could enter the body through the EXH port, solenoid valve EXH port and/or built-in regulator EXH port, thereby causing problems.
2. Do not operate in locations where vibration or impact occurs.
3. In locations which receive direct sunlight, provide a protective cover etc.
4. In locations near heat sources, block off any radiated heat.
5. Employ suitable protective measures in locations where there is contact with water droplets, oil or welding spatter, etc.

### Fluid Supply

#### Warning

1. Compressed air or nitrogen can be used as a fluid.
2. Do not use compressed air which includes chemicals, synthetic oils containing organic solvents, salt, or corrosive gases, etc., as this can cause damage or malfunction.

#### Caution

1. This product does not have a filtering function. Install an air filter on the supply side close to the product. Select an air filter with a filtration degree of 5 µm or finer.
2. Compressed air containing large amounts of drainage can cause a malfunction of this product and other pneumatic equipment. As a countermeasure, install an aftercooler, air dryer or water separator, etc.
3. If large amounts of carbon dust are generated by the compressor, it can accumulate inside this product and cause a malfunction (air leakage etc.).

For details on the above compressed air quality, refer to "Air Preparation Equipment Model Selection Guide" .



# Series ITVH2000

## Specific Product Precautions 2

Be sure to read this before handling. Refer to the back cover for Safety Instructions. For F.R.L. Precautions, refer to "Handling Precautions for SMC Products" and the Operation Manual on SMC website, <http://www.smc.eu>

### Handling

#### ⚠ Caution

1. Do not use a lubricator on the supply side of this product, as this can cause a malfunction.
2. If electric power is shut off while pressure is being applied, pressure will be retained on the output side. However, this output pressure is held only temporarily and is not guaranteed. If exhausting of this pressure is desired, shut off the power after reducing the set pressure, and discharge the air using a residual pressure exhaust valve etc.
3. If power to this product is cut off due to a power failure etc. when it is in a controlled state, output pressure will be retained temporarily. Handle carefully when operating with output pressure released to the atmosphere, as air will continue to flow out.
4. If supply pressure to this product is interrupted while the power is still on, the internal solenoid valve will continue to operate and a humming noise may be generated. Since the life of the product may be shortened, shut off the power supply also when supply pressure is shut off.
5. Do not block three EXH ports on this product.
6. This product does not have a shutoff valve function. If air pressure is supplied without electric power being applied, output pressure may increase to the pressure equivalent of the supply pressure. Due to product construction, a very small amount of air is discharged from the exhaust port when output pressure is generated. Operate the system to shut off the supply pressure when not operating the product.
7. The product is adjusted to each specification at the time of shipment from the factory. Do not perform unnecessary disassembly or removal of parts as it will cause failure.
8. The optional cable connector is a 4-core wire type. When the monitor output (analogue output or switch output) is not being used, keep it from touching the other wires as this can cause a malfunction.
9. Do not turn the right angle type cable connector. It does not rotate and is limited to only one entry direction.
10. Take the following steps to avoid a malfunction due to noise.
  - 1) Remove power supply noise during operation by installing a line filter etc. in the AC power line.
  - 2) For avoiding the influence of noise or static electricity, install this product and its wiring as far as possible from strong electric fields such as those of motors and power lines, etc.
  - 3) Be sure to implement protective measures against load surge for induction loads (solenoid valves, relays, etc.).
11. For details on the handling of this product, refer to the Operation Manual which is included with the product.

### Design/Selection

#### ⚠ Caution

1. The direct-current power supply to combine should be UL authorized power supply.

1) Limited voltage current circuit in accordance with UL508.  
A circuit in which power is supplied by the secondary coil of a transformer that meets the following conditions.

- Maximum voltage (with no load):  
30 [Vrms] (42.4 [V peak]) or less

- Maximum current:

1. 8 [A] or less (including when short circuited)
2. Limited by circuit protector (such as fuse) with the following ratings

No load voltage [V peak]	Max. current rating [A]
0 to 20 [V]	5.0
Over 20 [V] to 30 [V]	100 Peak voltage

- 2) A circuit using max. 30 [Vrms] or less (42.4 [V peak]), which is powered by UL1310 or UL1585 compatible Class-2 power supply.

2. Operate these products only within the specified voltage.

Using voltages beyond the specified levels could cause faults or malfunctions.

3. Use 0 V as the baseline for the power supplied to this product for output, control and input.

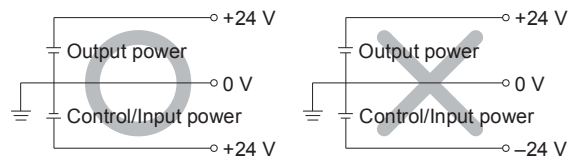

4. Each product needs to be powered by one power supply unit.

The wiring of this product has the same common between the GND for power and the signals; there is a possibility that a wrong current occurs and prevents a proper operation if one power supply unit controls multiple electro-pneumatic regulators.

5. Please contact SMC for the usage when the downstream side is released to atmosphere.

This product is a pressure controller. The downstream side being released to atmosphere makes the inlet valve fully open, allowing a large amount of atmosphere flow into the body. Please contact SMC for the appropriate usage when you use the product under such condition since the product may not meet the specification or the life of the product may be shortened.



# Series ITVH2000 Specific Product Precautions 3

Be sure to read this before handling. Refer to the back cover for Safety Instructions. For F.R.L. Precautions, refer to "Handling Precautions for SMC Products" and the Operation Manual on SMC website, <http://www.smc.eu>

## Wiring

### ⚠ Caution

Connect the cable to the connector on the body with the wiring arranged as shown below. Proceed carefully, as incorrect wiring can cause damage. Further, use DC power with sufficient capacity and a low ripple.

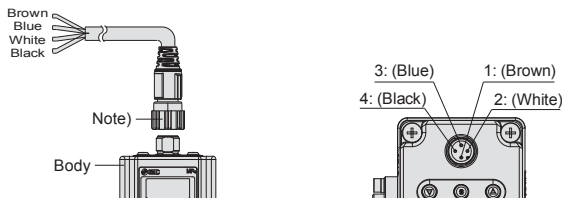

Note) The cable is also available in a right angle type. A right angle type connector is attached facing left (toward the SUP port). Do not attempt to rotate, as the connector does not turn.

#### Current Signal Type Voltage Signal Type

1	Brown	Power supply
2	White	Input signal
3	Blue	GND (COMMON)
4	Black	Monitor output

#### Preset Input Type

1	Brown	Power supply
2	White	Input signal 1
3	Blue	GND (COMMON)
4	Black	Input signal 2

#### Wiring diagram

##### Current signal type

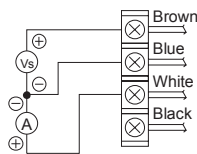

Vs: Power supply 24 VDC  
A: Input signal 4 to 20 mA DC  
0 to 20 mA DC

##### Voltage signal type

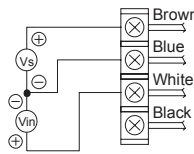

Vs: Power supply 24 VDC  
Vin: Input signal 0 to 5 VDC  
0 to 10 VDC

##### 4 points preset input type

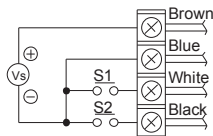

Vs: Power supply 24 VDC  
(Negative common)

One of the preset pressures P1 through P4 is selected by the ON/OFF combination of S1 and S2.

S1	OFF	ON	OFF	ON
S2	OFF	OFF	ON	ON
Preset pressure	P01	P02	P03	P04

\*For safety reasons, it is recommended that one of the preset pressures be set to 0 MPa.

\*Preset pressures are set based on the minimum unit for output display.

MPa	kgf/cm <sup>2</sup>	bar	psi
0.01	0.1	0.1	1

#### F.G. (Grounding)

Ground the frame ground (F.G.) terminal at the front of the main body. If the F.G. terminal port is not used, this product may not operate properly due to the noise.

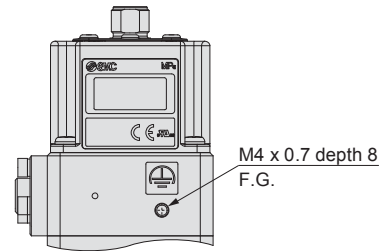

#### Monitor output wiring diagram

##### Analogue output: Voltage type

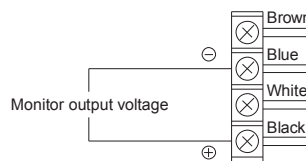

##### Analogue output: Current type (Sink type)

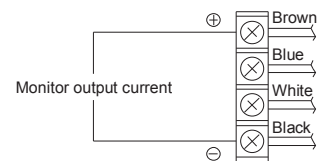

##### Switch output: NPN type

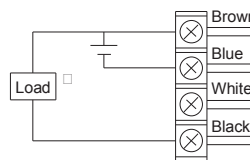

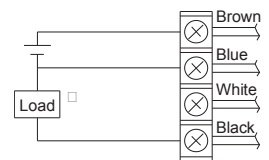

##### Switch output: PNP type



\*When 80 mA DC or more is applied, detecting device for over current starts activating and then emits an error signal. (Error number "5")

## Safety Instructions

These safety instructions are intended to prevent hazardous situations and/or equipment damage. These instructions indicate the level of potential hazard with the labels of "Caution," "Warning" or "Danger." They are all important notes for safety and must be followed in addition to International Standards (ISO/IEC)<sup>\*1)</sup>, and other safety regulations.

-  **Caution:** Caution indicates a hazard with a low level of risk which, if not avoided, could result in minor or moderate injury.
-  **Warning:** Warning indicates a hazard with a medium level of risk which, if not avoided, could result in death or serious injury.
-  **Danger:** Danger indicates a hazard with a high level of risk which, if not avoided, will result in death or serious injury.

- \*1) ISO 4414: Pneumatic fluid power – General rules relating to systems.
- ISO 4413: Hydraulic fluid power – General rules relating to systems.
- IEC 60204-1: Safety of machinery – Electrical equipment of machines. (Part 1: General requirements)
- ISO 10218-1: Manipulating industrial robots - Safety. etc.

### Warning

- The compatibility of the product is the responsibility of the person who designs the equipment or decides its specifications. Since the product specified here is used under various operating conditions, its compatibility with specific equipment must be decided by the person who designs the equipment or decides its specifications based on necessary analysis and test results. The expected performance and safety assurance of the equipment will be the responsibility of the person who has determined its compatibility with the product. This person should also continuously review all specifications of the product referring to its latest catalogue information, with a view to giving due consideration to any possibility of equipment failure when configuring the equipment.
- Only personnel with appropriate training should operate machinery and equipment. The product specified here may become unsafe if handled incorrectly. The assembly, operation and maintenance of machines or equipment including our products must be performed by an operator who is appropriately trained and experienced.
- Do not service or attempt to remove product and machinery/equipment until safety is confirmed.
  - The inspection and maintenance of machinery/equipment should only be performed after measures to prevent falling or runaway of the driven objects have been confirmed.
  - When the product is to be removed, confirm that the safety measures as mentioned above are implemented and the power from any appropriate source is cut, and read and understand the specific product precautions of all relevant products carefully.
  - Before machinery/equipment is restarted, take measures to prevent unexpected operation and malfunction.
- Contact SMC beforehand and take special consideration of safety measures if the product is to be used in any of the following conditions.
  - Conditions and environments outside of the given specifications, or use outdoors or in a place exposed to direct sunlight.
  - Installation on equipment in conjunction with atomic energy, railways, air navigation, space, shipping, vehicles, military, medical treatment, combustion and recreation, or equipment in contact with food and beverages, emergency stop circuits, clutch and brake circuits in press applications, safety equipment or other applications unsuitable for the standard specifications described in the product catalogue.
  - An application which could have negative effects on people, property, or animals requiring special safety analysis.
  - Use in an interlock circuit, which requires the provision of double interlock for possible failure by using a mechanical protective function, and periodical checks to confirm proper operation.

## Limited warranty and Disclaimer/ Compliance Requirements

The product used is subject to the following "Limited warranty and Disclaimer" and "Compliance Requirements".  
Read and accept them before using the product.

### Limited warranty and Disclaimer

- The warranty period of the product is 1 year in service or 1.5 years after the product is delivered, whichever is first.<sup>\*2)</sup>  
Also, the product may have specified durability, running distance or replacement parts. Please consult your nearest sales branch.
- For any failure or damage reported within the warranty period which is clearly our responsibility, a replacement product or necessary parts will be provided. This limited warranty applies only to our product independently, and not to any other damage incurred due to the failure of the product.
- Prior to using SMC products, please read and understand the warranty terms and disclaimers noted in the specified catalogue for the particular products.

<sup>\*2)</sup> Vacuum pads are excluded from this 1 year warranty.

A vacuum pad is a consumable part, so it is warranted for a year after it is delivered. Also, even within the warranty period, the wear of a product due to the use of the vacuum pad or failure due to the deterioration of rubber material are not covered by the limited warranty.

### Caution

- The product is provided for use in manufacturing industries. The product herein described is basically provided for peaceful use in manufacturing industries. If considering using the product in other industries, consult SMC beforehand and exchange specifications or a contract if necessary. If anything is unclear, contact your nearest sales branch.

### Caution

SMC products are not intended for use as instruments for legal metrology. Measurement instruments that SMC manufactures or sells have not been qualified by type approval tests relevant to the metrology (measurement) laws of each country. Therefore, SMC products cannot be used for business or certification ordained by the metrology (measurement) laws of each country.

## Safety Instructions

Be sure to read "Handling Precautions for SMC Products" (M-E03-3) before using.

### SMC Corporation (Europe)

Austria	☎ +43 (0)2262622800	www.smc.at	office@smc.at	Lithuania	☎ +370 5 2308118	www.smclt.lt	info@smclt.lt
Belgium	☎ +32 (0)33551464	www.smcpnautics.be	info@smcpneautics.be	Netherlands	☎ +31 (0)205318888	www.smcpnautics.nl	info@smcpneautics.nl
Bulgaria	☎ +359 (0)2807670	www.smc.bg	office@smc.bg	Norway	☎ +47 67129020	www.smc-norge.no	post@smc-norge.no
Croatia	☎ +385 (0)13707288	www.smc.hr	office@smc.hr	Poland	☎ +48 (0)222119616	www.smc.pl	office@smc.pl
Czech Republic	☎ +420 541424611	www.smc.cz	office@smc.cz	Portugal	☎ +351 226166570	www.smc.eu	postpt@smc.smces.es
Denmark	☎ +45 70252900	www.smcdk.com	smc@smcdk.com	Romania	☎ +40 213205111	www.smcronania.ro	smcronania@smcronania.ro
Estonia	☎ +372 6510370	www.smcpnautics.ee	smc@smcpneautics.ee	Russia	☎ +7 8127185445	www.smc-pneumatik.ru	info@smc-pneumatik.ru
Finland	☎ +358 207513513	www.smc.fi	smc@smc.fi	Slovakia	☎ +421 (0)413213212	www.smc.sk	office@smc.sk
France	☎ +33 (0)164761000	www.smc-france.fr	promotion@smc-france.fr	Slovenia	☎ +386 (0)73885412	www.smc.si	office@smc.si
Germany	☎ +49 (0)61034020	www.smc.de	info@smc.de	Spain	☎ +34 902184100	www.smc.eu	post@smc.smces.es
Greece	☎ +30 210 2717265	www.smchellas.gr	sales@smchellas.gr	Sweden	☎ +46 (0)86031200	www.smc.nu	post@smc.nu
Hungary	☎ +36 23511390	www.smc.hu	office@smc.hu	Switzerland	☎ +41 (0)523963131	www.smc.ch	info@smc.ch
Ireland	☎ +353 (0)14039000	www.smcpnautics.ie	sales@smcpneautics.ie	Turkey	☎ +90 212 489 0 440	www.smcpnomatik.com.tr	info@smcpnomatik.com.tr
Italy	☎ +39 0292711	www.smcitalia.it	mailbox@smcitalia.it	UK	☎ +44 (0)845 121 5122	www.smcpnautics.co.uk	sales@smcpneautics.co.uk
Latvia	☎ +371 67817700	www.smclv.lv	info@smclv.lv				

SMC CORPORATION Akihara UDX 15F, 4-14-1, Sotokanda, Chiyoda-ku, Tokyo 101-0021, JAPAN Phone: 03-5207-8249 FAX: 03-5298-5362

